



Mobercas

Výrobce polohovacích lůžek a křesel

KATALOG 2013 -2014



KRÁSNÝ - zdravotnická technika s.r.o.

<b>NAŠE SLUŽBY</b>	<b>VYRÁBÍME PRO VÁS</b>
<b>NAVRHOVÁNÍ A VÝVOJ NOVÝCH VÝROBKŮ</b> Návrh a vývoj nových výrobků na základě doporučení a stanovisek lékařských profesionálů a také inovace modelů, které jsou již na trhu při dalším zlepšování kvality lékařské péče o pacienty a práce odborníků.	<ul style="list-style-type: none"> <li>• Speciální a prodloužené rozměry</li> <li>• Motorem ovládané nastavení hlavové části</li> <li>• Zákaznický uzpůsobené návrhy</li> <li>• Zákaznický uzpůsobené polštáře</li> </ul>
<b>PORADENSTVÍ V OTÁZKÁCH PÉČE A OSOBNĚ ZAMĚŘENÉ INFORMACE</b> <b>PORADENSTVÍ V OTÁZKÁCH PÉČE A OSOBNĚ ZAMĚŘENÉ INFORMACE</b> Poradenství v otázkách péče a osobně zaměřené informace pro zajištění vhodného a přesně zvoleného výrobku. Vždy bereme zřetel na odlišné potřeby našich zákazníků.	<b>NÁŠ SORTIMENT</b> <ul style="list-style-type: none"> <li>• Vyšetřovací lehátka s pevnou výškou</li> <li>• Elektricky ovládaná vyšetřovací lehátka</li> <li>• Hydraulicky ovládaná vyšetřovací lehátka</li> <li>• Pediatrická lehátka</li> <li>• Osteopatická a chiropraktická lehátka</li> <li>• Bariatrická lehátka</li> <li>• Vyšetřovací lehátka s pevnou výškou se snímatelnými nohami</li> <li>• Transportní vozíky</li> <li>• Pedikérská lehátka</li> <li>• Gynekologická lehátka</li> <li>• Vyšetřovací lehátka</li> <li>• Bariatrické židle</li> </ul>
<b>LOGISTIKA A ŘÍZENÍ SKLADU</b> Logistika a řízení skladu poskytují snížení nákladů a přidanou hodnotu našich služeb. Řídíme přepravu z provozovny až do rukou zákazníka, aniž by distributor musel zajišťovat skladovací prostory.	
<b>TECHNICKÁ PODPORA</b> Poskytujeme technickou podporu ve formě konzultací u speciálních modelů nebo slučování dvou modelů do jednoho a možnostech využití pro rozličné terapie.	
<b>POPRODEJNÍ SERVIS</b> Poprodejný servis pokrývá údržbu, technickou podporu, opravy a služby v rámci záruky.	

<ul style="list-style-type: none"> <li>• Antimikrobiální ochrana</li> <li>• Antibakteriální ochrana</li> <li>• Antimykotická ochrana</li> <li>• Vysoká odolnost proti otěru</li> <li>• Odolnost vůči moči</li> <li>• Odolnost vůči krvi</li> </ul>	<ul style="list-style-type: none"> <li>• Odolnost vůči UV záření</li> <li>• Nepropustnost</li> <li>• REFERENCE VÝROBKŮ</li> <li>• Odolnost vůči slunečnicovému oleji</li> <li>• Povrch odolný vůči vzniku skvrn</li> <li>• Splňuje normu UNE-EN-71/3 (bezpečnost hraček).</li> </ul>
--	--



SNIŽENÁ HOŘLAVOST					
E	<ul style="list-style-type: none"> <li>• UNE 23.727-90 1R/M.2</li> <li>• UNE EN 1021 / část 1 a 2</li> </ul>	GB	<ul style="list-style-type: none"> <li>• BS EN 1021 / část 1 a 2</li> </ul>	A	<ul style="list-style-type: none"> <li>• ÖNORM B 3825 Gruppe 1, schwerbrennbares</li> <li>• ÖNORM B 3800 Tell 1 Qualmbildungsklasse Q1 schawchqualmend</li> </ul>
F	<ul style="list-style-type: none"> <li>• NF EN 1021 / část 1 a 2</li> <li>• NF P 92-503/M2</li> </ul>	I	<ul style="list-style-type: none"> <li>• UNI EN 1021 / část 1 a 2</li> <li>• UNI 9175 (1987) - UNI 9175/FA1 (1994)</li> <li>• UNI 8456 (1987) třída 1</li> <li>• UNI 9174 (1987) - UNI 9174/A1 třída 2</li> </ul>	MEZINÁRODNÍ	<ul style="list-style-type: none"> <li>• IMO A.662 (16) Příloha 1, 8.2 a 8,3</li> <li>• (IMED) směrnice rady 96/98 EC o námořním zařízení</li> </ul>
D	<ul style="list-style-type: none"> <li>• DIN 4102 B2</li> <li>• DIN EN 1021 / část 1/2</li> <li>• DIN 53 438</li> <li>• DIN 75 200</li> </ul>	EU	<ul style="list-style-type: none"> <li>• EN 1021 / část 1 a 2</li> <li>• EN 71/2</li> </ul>	USA	<ul style="list-style-type: none"> <li>• MVSS 302</li> <li>• FAR 25/853</li> </ul>
NA VYŽÁDÁNÍ					



Visita nuestra web:  
[www.mobercas.com](http://www.mobercas.com)

**PEVNÁ VÝŠKA**



**CD-F1**

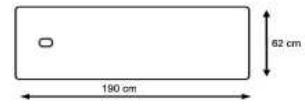

**CD-F2**

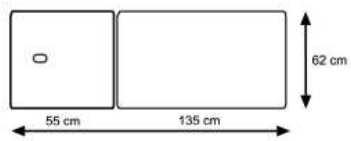

**CF-BASKET**

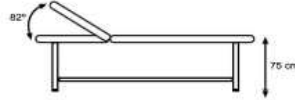
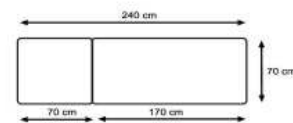

**CF-XXL**



ELEKTRICKÁ A HYDRAULICKÁ POLOHOVACÍ LŮŽKA



CE-2223

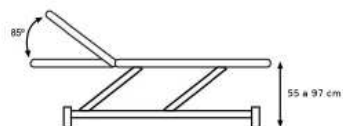

CE-0120-R

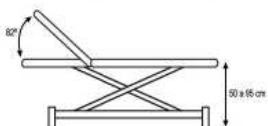
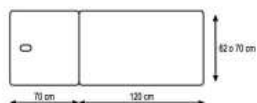

CE-0120-R.BAR

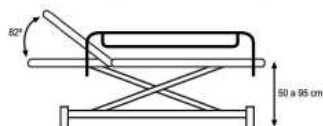
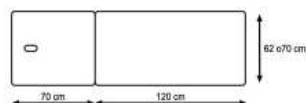

CH/CE-0127

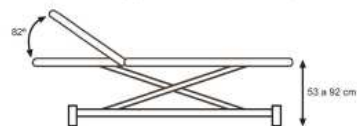

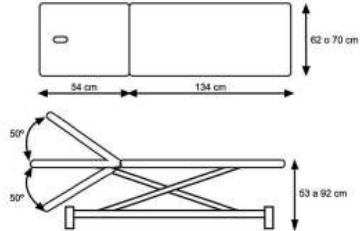
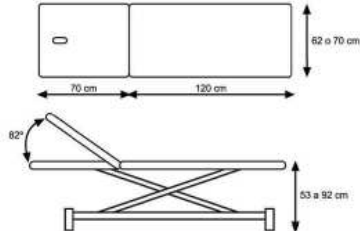
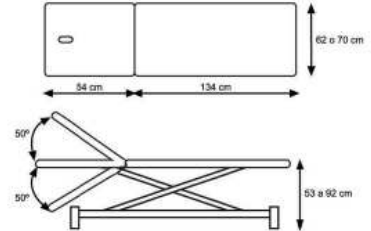
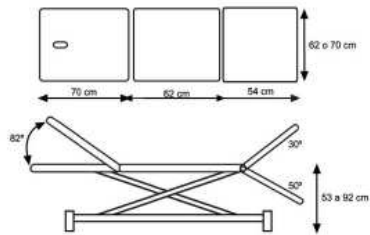
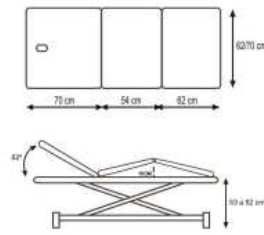
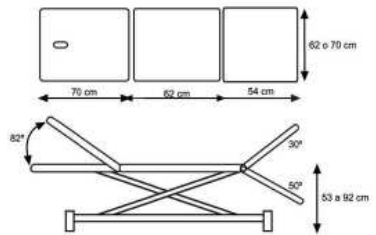

**CH/CE-0127-A****CH/CE-0127-R****CH/CE-0127-AR****CH/CE-0137****CH/CE-0137-PC****CH/CE-0137-R**

CH/CE-0137-RPC

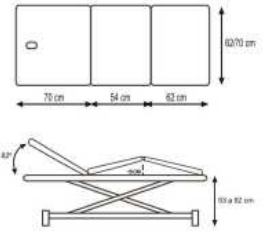

CH/CE-2120

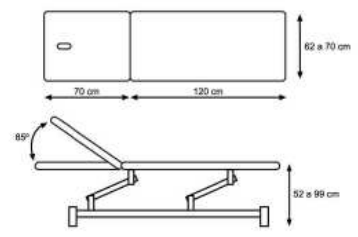

CH/CE-2120-BP

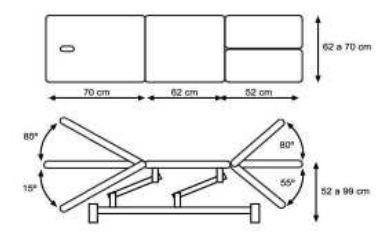

CH/CE-2120-R

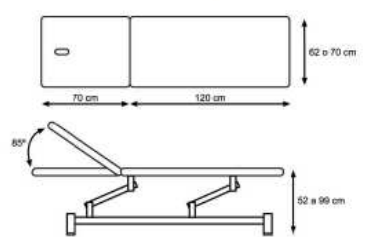

CE-2121

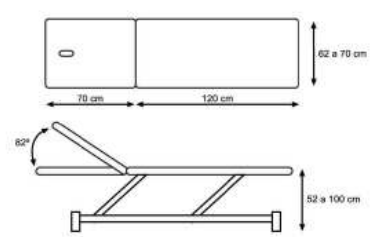

CH/CE-2125

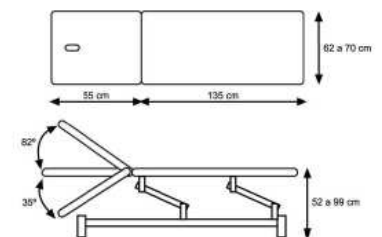

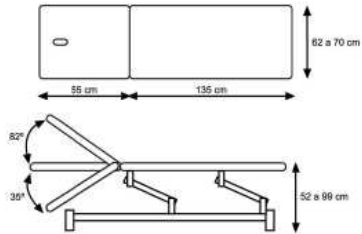
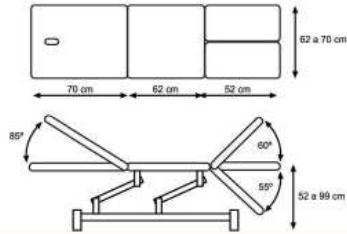
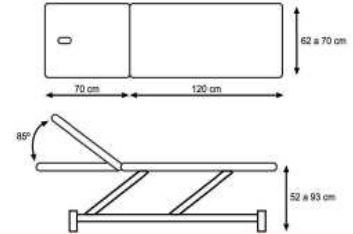
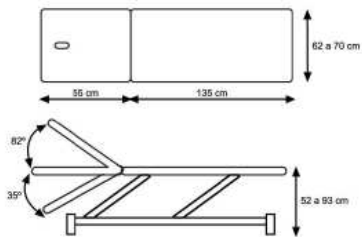
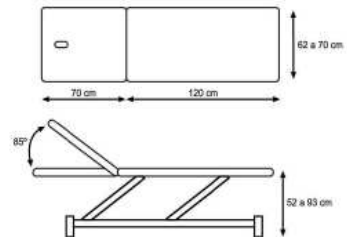
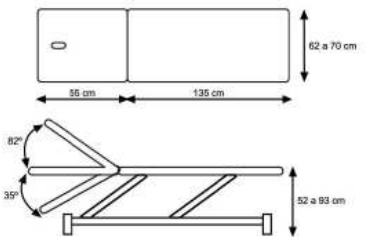
**CH/CE-2125-R****CH/CE-2126-R****CH/CE-2127****CH/CE-2127-A****CH/CE-2127-R****CH/CE-2127-AR**

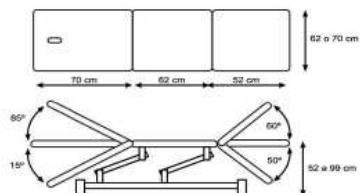
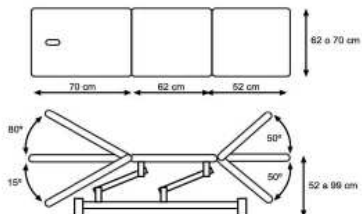
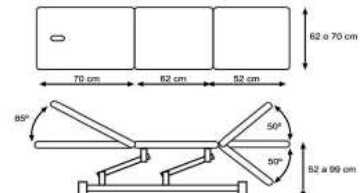
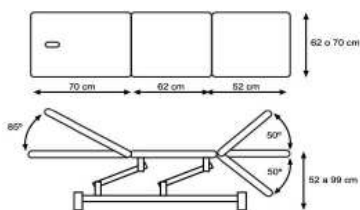
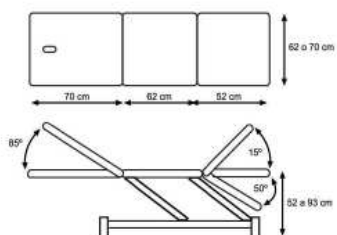
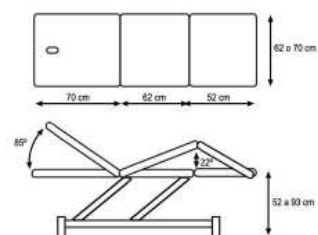

**CH/CE-2130****CH/CE-2130-R****CH/CE-2135****CH/CE-2135-R****CH/CE-2137****CH/CE-2137-PC**

CH/CE-2137-RPC

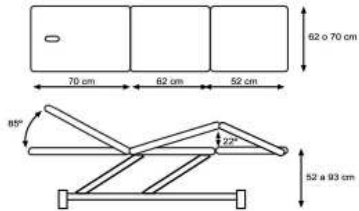

CE-2220-R

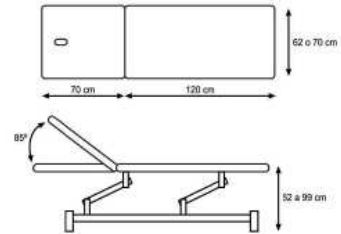

CE-2226-R

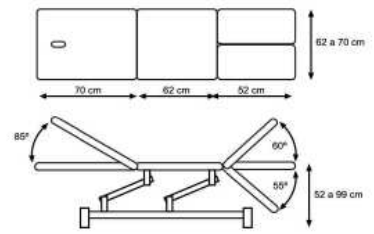

CE-2230-R

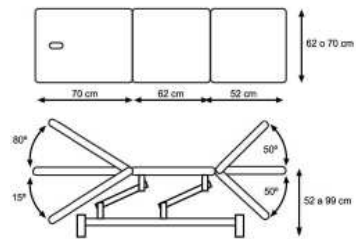

CE-2240-R

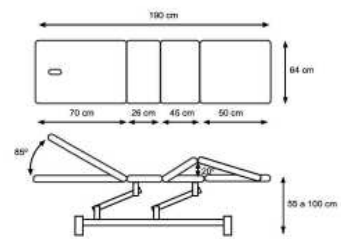

CE-2330-R

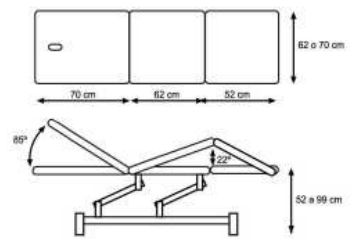

<b>MULTIFUNKČNÍ LŮŽKA</b>	<b>S-1030-E BEAUTY</b>	<b>S-1030-T TATTOO</b>
---------------------------	------------------------	------------------------



<b>CE-1130</b>	<b>CE-1130-AA</b>	<b>CE-1230</b>
----------------	-------------------	----------------

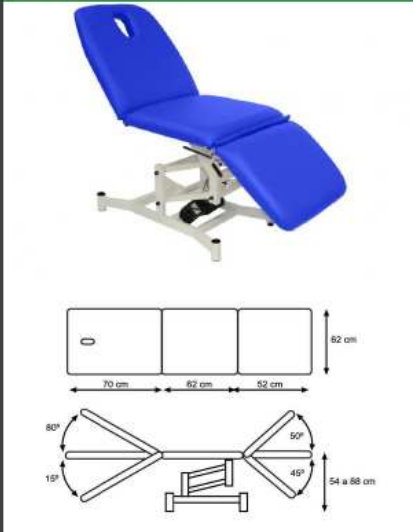
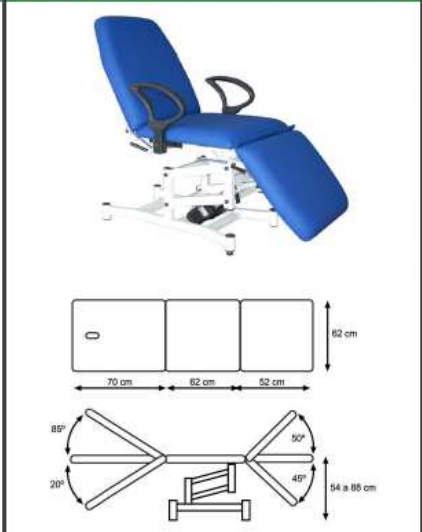
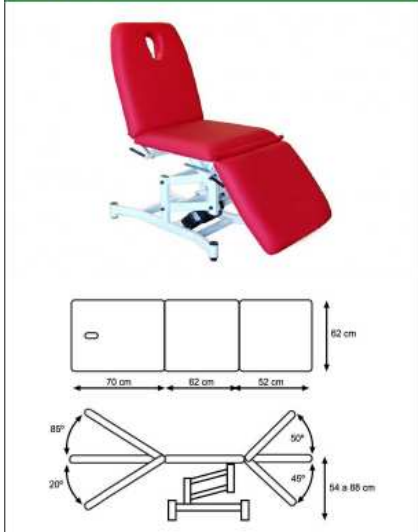

<b>CE-1140 OPHTHALMOLOGY</b>	<b>CE-1240</b>	<b>CE-2370-R DAY CARE</b>
------------------------------	----------------	---------------------------

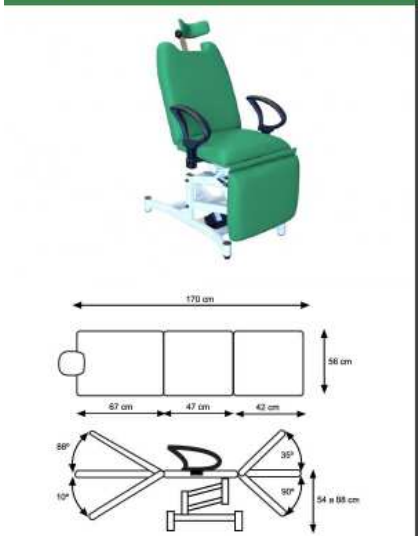



**S-1090-POD**      **CE-1150**      **CE-1250**

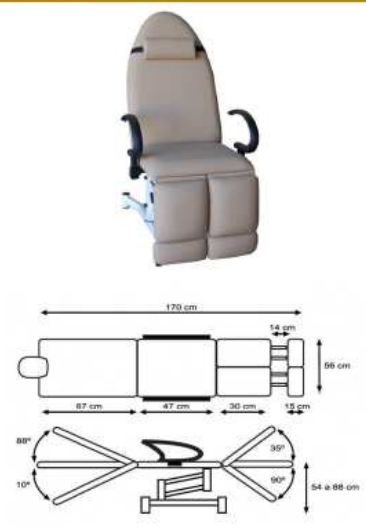
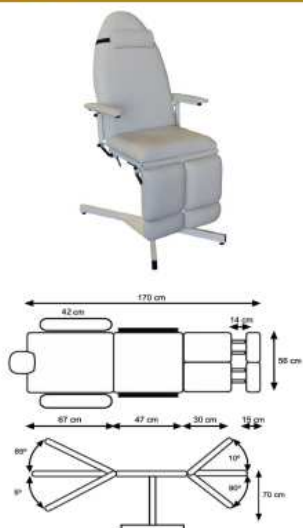

**CH/CE-2120-P**      **CH/CE-2120-PR**      **CE-2220-PR**

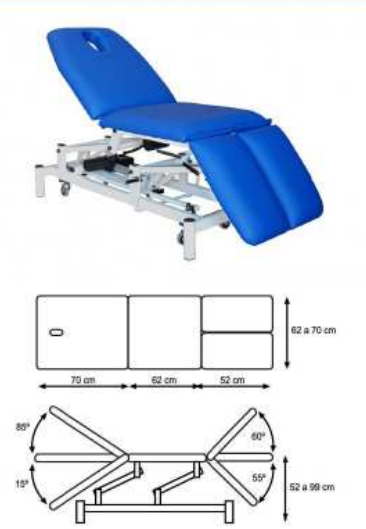



# KŘESLA PRO GYNEKOLOGII



S-1080-GIN      CE-1160-G      CE-1260-G

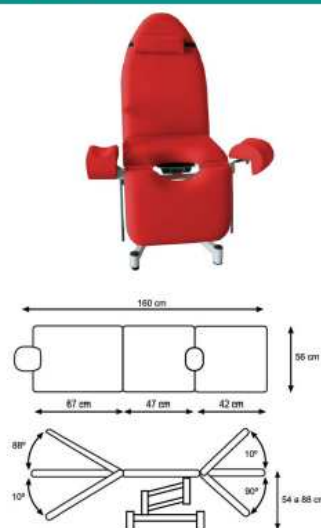
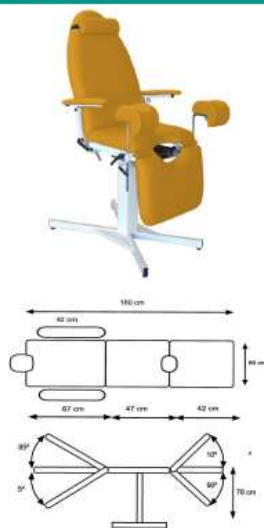

CE-1280-R      CE-1380-R      CE-0330-R

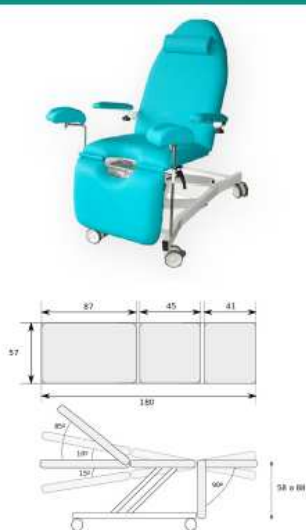



VÝROBKY PRO SPECIÁLNÍ ÚČELY



CH/CE-BOBATH 190

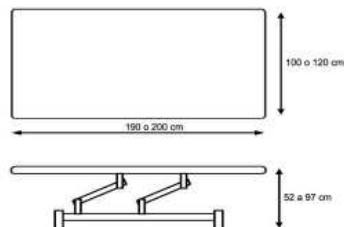

CH/CE-BOBATH RE-190	CH/CE-BOBATH TIJERA 190-200	CH/CE-BOBATH TIJERA RE-190-200
---------------------	-----------------------------	--------------------------------

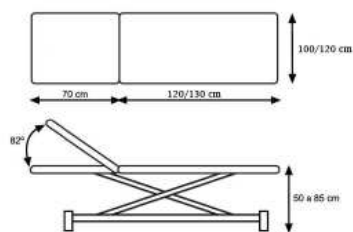
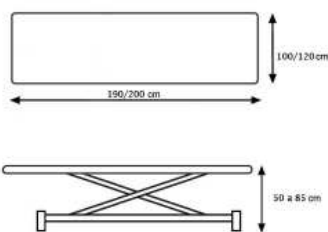
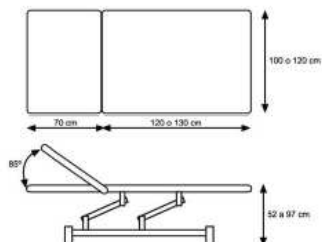

CE-2220-V FIJA	CE-2221-V REGULABLE	CTH-0120 TROLLEY
----------------	---------------------	------------------

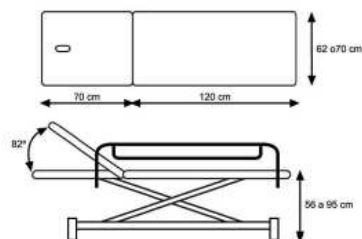
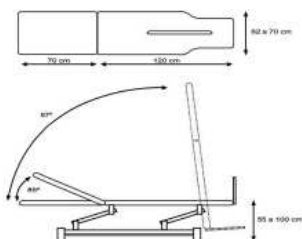
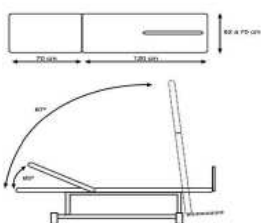

**PEDIATRIE**



**CH/CE-0120-R PEDIATRICA**

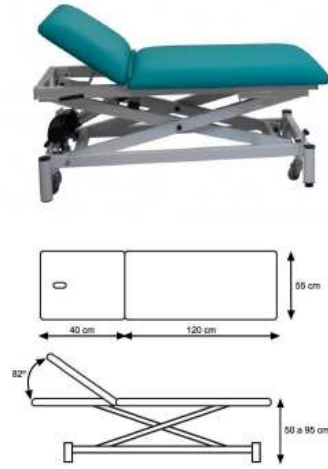

**CH/CE-0120-R.BAR PEDIATRICA**

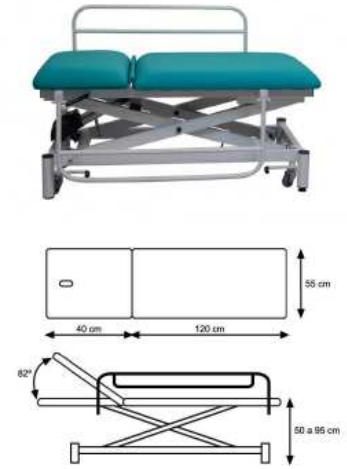

**CH/CE-2121-PEDIATRICA**



**OSTEOPATIE**

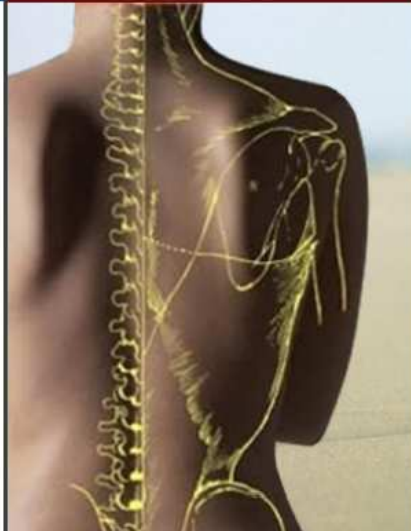

**CH/CE-0177-R**

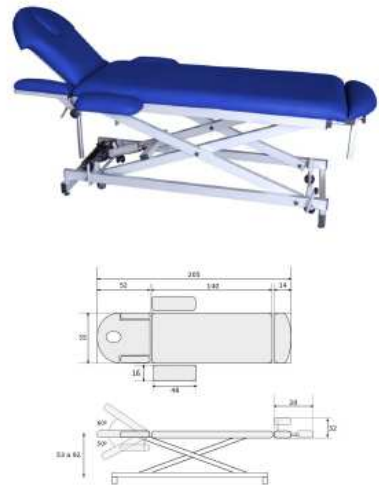

**CH/CE-0197-R**



**CE-2390-R**

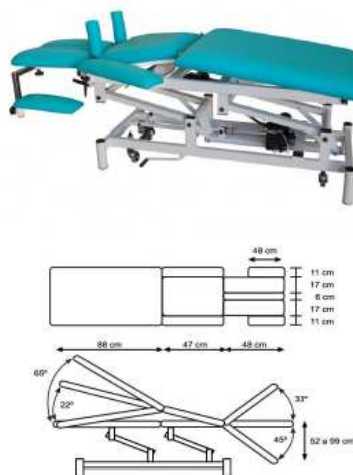

**CHIOS**

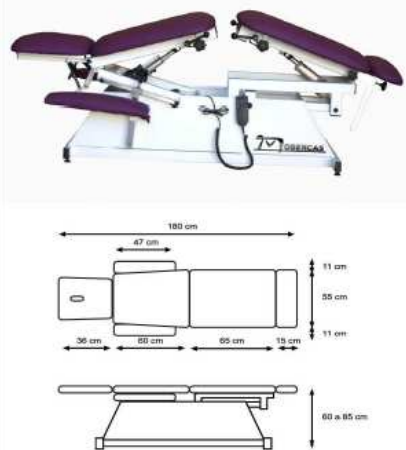

## VOLITELNÉ PŘÍSLUŠENSTVÍ



Ucpávka dýchacího otvoru



Ucpávka gynekologického křesla



Sada nožních opěrek



Individuálně nastavitelné sekce



Opěrky pro zavedení katetru



Výškové a úhlově nastavitelné opěrky



Plochá pažní opěrka



Pažní opěrky otočné o 180 stupňů



Nožní pedál pro ovládání 1 motoru



Nožní pedál pro ovládání 2 motorů



Jednoduché ovládání nohou



Bržděná kolečka s gumovým povrchem



Držák role hygienického papíru



Hydraulicky nastavitelná výška



Sklopné zábrany



Zatahovací postroj



Multifunkční stojánek



Inklinometr pro měření úhlu

## NABÍDKA BAREV



### Autorizovaný distributor a servis pro ČR

KRÁSNÝ - zdravotnická technika s.r.o.  
Přemyslova 25 (naproti OC PLAZA)  
301 00 PLZEŇ - Česká republika

E-shop: [www.szo.cz](http://www.szo.cz)



Telefon: 377 424 999